

Distributed by:



**Corrosion
Control
Equipment
and
Supplies**

Houston Office:
248 McCarty Dr.
Houston, TX 77029-1195
(713) 672-8251
Fax (713) 672-6636

1-800-CLEMTEX
www.clemtex.com
clemtex@clemtex.com

Dallas Branch:

4770 Gretna
Dallas, TX 75207
(214) 631-0584
Fax (214) 631-5824
1-800-BLAST 97

Corpus Christi Branch:

4750 Westway
Corpus Christi, TX 78408
(361) 882-8282
Fax (361) 882-6029



Binks SV100 HVLP Pressure Feed Spray Gun



The following instructions provide the necessary information for the proper maintenance of the Binks SV100 pressure feed spray gun. Please read and understand all the information in this document in order to get the maximum performance from your new SV100 pressure spray gun.

The SV100 spray gun is the result of quality engineering and development activity. The result is an ergonomic product with reduced triggering effort and fine atomization. The HVLP air cap has been specifically designed to comply with local regulatory air quality restrictions. The specification table details the operating parameters of the gun to achieve those compliant conditions. In addition, the relatively low air flow rate of the SV100 spray gun will help in containing overspray.

The SV100 spray gun should be operated under the safety directions outlined in this literature. Your safety and the safety of others depend on your thorough understanding of the material contained on the Part Sheet.

If you have any questions or do not understand the content in this literature, call your nearest service representative.

SPECIFICATIONS

Max. Air Pressure:	175psi/12bar
For HVLP Compliance: (with SV100-693K cap)	26 psi inlet pressure delivers 10 psi air cap pressures at 12 cfm air volume
For HVLP Compliance: (with SV100-690K cap)	20 psi inlet pressure delivers 10 psi air cap pressures at 6.5 cfm air volume
Gun Body:	Cast Aluminum
Fluid Path:	Stainless Steel
Fluid Nozzle:	Stainless Steel
Fluid Needle:	Stainless Steel
Fluid Inlet Size:	3/8" NPS(M)
Air Inlet Size:	1/4" NPS(M)
Gun Weight:	1.12 lbs. (507 g)

Replaces
Part Sheet
77-2874R

Part
Sheet
77-2874R-1

In this part sheet, the words **WARNING**, **CAUTION** and **NOTE** are used to emphasize important safety information as follows:

⚠ WARNING
 Hazards or unsafe practices which could result in severe personal injury, death or substantial property damage.

⚠ CAUTION
 Hazards or unsafe practices which could result in minor personal injury, product or property damage.

NOTE
 Important installation, operation or maintenance information.

⚠ WARNING

Read the following warnings before using this equipment.



READ THE MANUAL
 Before operating finishing equipment, read and understand all safety, operation and maintenance information provided in the operation manual.



WEAR SAFETY GLASSES
 Failure to wear safety glasses with side shields could result in serious eye injury or blindness.

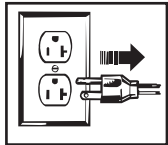

DE-ENERGIZE, DISCONNECT AND LOCK OUT ALL POWER SOURCES DURING MAINTENANCE
 Failure to De-energize, disconnect and lock out all power supplies before performing equipment maintenance could cause serious injury or death.



OPERATOR TRAINING
 All personnel must be trained before operating finishing equipment.



EQUIPMENT MISUSE HAZARD
 Equipment misuse can cause the equipment to rupture, malfunction, or start unexpectedly and result in serious injury.



KEEP EQUIPMENT GUARDS IN PLACE
 Do not operate the equipment if the safety devices have been removed.

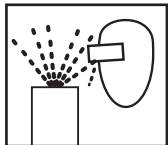

PROJECTILE HAZARD
 You may be injured by venting liquids or gases that are released under pressure, or flying debris.



PINCH POINT HAZARD
 Moving parts can crush and cut. Pinch points are basically any areas where there are moving parts.



AUTOMATIC EQUIPMENT
 Automatic equipment may start suddenly without warning.



INSPECT THE EQUIPMENT DAILY
 Inspect the equipment for worn or broken parts on a daily basis. Do not operate the equipment if you are uncertain about its condition.



NEVER MODIFY THE EQUIPMENT
 Do not modify the equipment unless the manufacturer provides written approval.



KNOW WHERE AND HOW TO SHUT OFF THE EQUIPMENT IN CASE OF AN EMERGENCY



PRESSURE RELIEF PROCEDURE
 Always follow the pressure relief procedure in the equipment instruction manual.



NOISE HAZARD
 You may be injured by loud noise. Hearing protection may be required when using this equipment.



STATIC CHARGE
 Fluid may develop a static charge that must be dissipated through proper grounding of the equipment, objects to be sprayed and all other electrically conductive objects in the dispensing area. Improper grounding or sparks can cause a hazardous condition and result in fire, explosion or electric shock and other serious injury.



FIRE AND EXPLOSION HAZARD
 Never use 1,1,1-trichloroethane, methylene chloride, other halogenated hydrocarbon solvents or fluids containing such solvents in equipment with aluminum wetted parts. Such use could result in a serious chemical reaction, with the possibility of explosion. Consult your fluid suppliers to ensure that the fluids being used are compatible with aluminum parts.

FOR FURTHER SAFETY INFORMATION REGARDING BINKS AND DEVILBISS EQUIPMENT, SEE THE GENERAL EQUIPMENT SAFETY BOOKLET (77-5300).

TYPES OF INSTALLATION

PRESSURE CUP HOOKUP (Figure 1)

For fine finishing with limited spraying. Air pressure for atomization is regulated at extractor; fluid pressure at cup regulator. Pressure cup is also available less regulator.

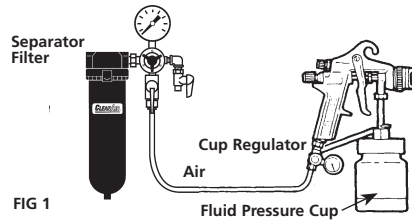

FIG 1

PRESSURE TANK HOOKUP (Figure 2)

For medium production spraying (single regulator). Air pressure for atomization is regulated at extractor, fluid pressure at tank regulator.

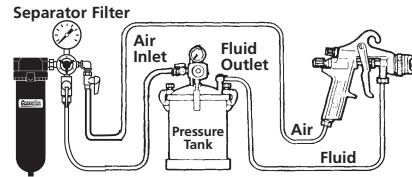

FIG 2

PRESSURE TANK WITH 2 REGULATORS (Figure 3)

The pressure to the tank is regulated by the first regulator. The pressure for atomization is regulated by the second regulator.

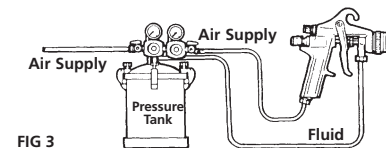

FIG 3

PRESSURE CIRCULATING HOOKUP (Figure 4)

For heavy production spraying. Air pressure atomization regulated at separator filter. Fluid pressure regulated at fluid regulator.

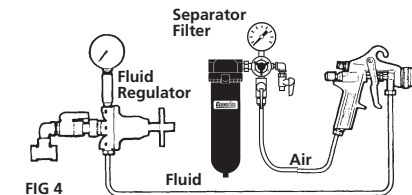

FIG 4

AIR PRESSURE

Atomizing pressure must be set properly to allow for the drop in air pressure between the regulator and the spray gun.



Only 43 PSI at gun inlet
25 feet of 1/4" I.D. hose causes a drop of 17 PSI between the air supply and the gun.

(NOT RECOMMENDED)

With 60 psi applied at air supply



Cross section view showing comparison of inside hose diameters (actual size). 60 lbs. regulated pressure



54 PSI at gun inlet
25 feet of 5/16" I.D. hose causes a drop of 6 PSI between the air supply and the gun. For this reason Binks recommends the use of 5/16" hose.

(RECOMMENDED)

Separator filter is important.

Achieving a fine spray finish without the use of a good separator filter is virtually impossible.

A regulator / separator filter serves a double purpose. It eliminates blistering and spotting by keeping air free of oil and water, and it gives precise air pressure control at the gun.

Binks recommends using Model HFRL-508 Separator Filter / Regulator. See your local distributor for other models.

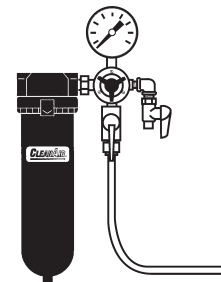

OPERATION AND MAINTENANCE FOR SV100 HVLP SPRAY GUN

Your new SV100 HVLP spray gun is exceptionally rugged in construction and is built to stand up under hard, continuous use. However, like any other fine precision instrument, its most efficient operation depends on a knowledge of its construction, operation and maintenance. Properly handled and cared for, it will produce beautiful, uniform finishing results long after other spray guns have worn out.

SET-UP FOR SPRAYING

Connecting Gun To Air Hose

Air should be supplied by a suitable length of 5/16" diameter air hose fitted with a 1/4" NPS(f) connection at gun end. For hose lengths over 50', use 3/8" diameter hose.

Connecting Gun To Fluid Hose

Fluid should be supplied by a suitable length of 3/8" diameter fluid hose fitted with a 5/16" NPS(f) connection at gun end. 1/4" diameter hose is recommended for use with low viscosity fluids. (Fluid hoses of different composition are available for special fluids.)

SPRAY GUN CLEANING INSTRUCTIONS

In certain states it is now against the law to spray solvents containing Volatile Organic Compounds (VOC)'s into the atmosphere when cleaning a spray gun.

In order to comply with these air quality laws Binks recommends one of the following two methods to clean your spray finishing equipment:

1. Spray solvent through the gun into a closed system. An enclosed unit or spray gun cleaning station condenses solvent vapors back into liquid form which prevents escape of VOC's into the atmosphere.
2. Place spray gun in a washer type cleaner. This system must totally enclose the spray gun, cups, nozzles and other parts during washing, rinsing and draining cycles. This type of unit must be able to flush solvent through the gun without releasing any VOC vapors into the atmosphere.

Additionally, open containers for storage or disposal of solvent or solvent-containing cloth or paper used for surface preparation and clean-up may not be used. All containers shall be nonabsorbent.

Pointers On Cleaning

When used with 1 quart cup, relieve pressure in the cup. Then unscrew, empty and carefully rinse cup out with thinners. Place clean thinners in the cup and spray this through the gun until it is clean. Blow air through gun to dry it.

When Used With Pressure Container

Shut off air supply to container and release the pressure on the container. Loosen retaining ring two turns, hold a piece of cloth wadded in the hand over the gun nozzle and pull the trigger. The air will back up through the fluid nozzle and force the fluid out of the hose into the container. Empty container. Put enough thinner into the container to wash hose and gun thoroughly and spray this through the gun until it is clean. Then blow out the fluid hose to dry it and remove all traces of fluid by attaching it to the air line.

When used with Paint Circulating System

Shut off fluid supply and remove fluid hose from gun. Clean gun with compatible solvent. To ensure a clean air supply to your spray gun, use separator filter. See your Binks distributor for the correct model.

CAUTION

All parts on a spray gun should be screwed in hand tight at first; this will avoid the possibility of cross threading the parts. If the parts cannot be turned by hand easily, make sure you have the correct parts, unscrew, realign, and try again. NEVER use undue force in mating parts.

BINKS SV100 HVLP PRESSURE FEED SPRAY GUN

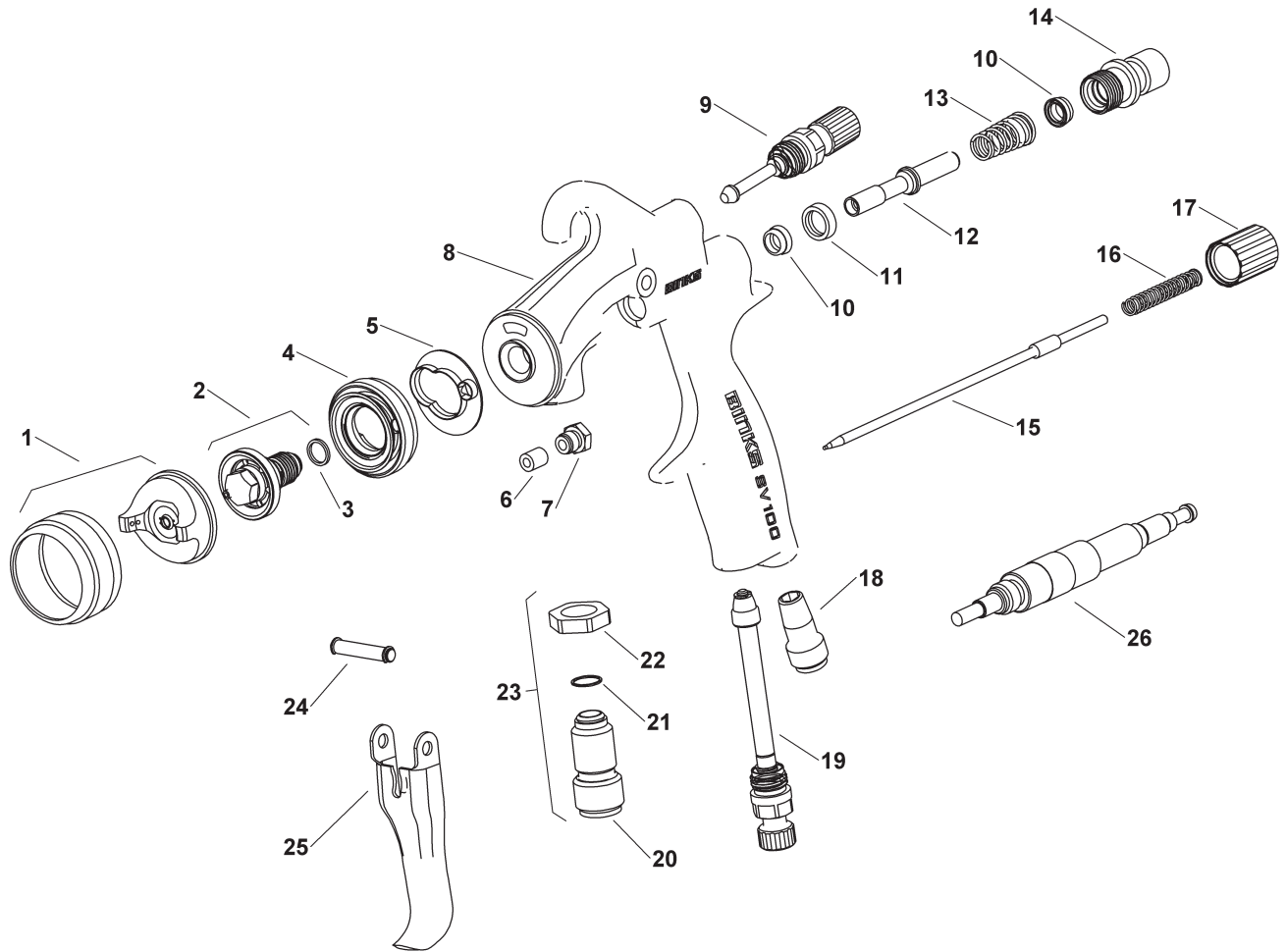

PARTS LIST

(When ordering, please specify Part No.)

ITEM NO.	PART NO.	DESCRIPTION	QTY.	ITEM NO.	PART NO.	DESCRIPTION	QTY.
1	SV100-693K	AIR CAP	1	15★	—	FLUID NEEDLE 1.1 mm.....	1
1a	SV100-690K	AIR CAP (not shown).....	1	15a★	—	FLUID NEEDLE 1.4 mm (not shown)..	1
2★	—	FLUID TIP 1.1 mm	1	15b•	—	FLUID NEEDLE 1.8 mm (not shown)..	1
2a★	—	FLUID TIP 1.4 mm (not shown).....	1	16★	—	FLUID NEEDLE SPRING.....	1
2b•	—	FLUID TIP 1.8 mm (not shown).....	1	17	—	FLUID ADJUSTMENT KNOB	1
3★■	—	GASKET.....	1	18	—	NIPPLE.....	1
4	—	BAFFLE.....	1	19	SGK-457	AIR ADJUSTING VALVE ASSEMBLY ...	1
5★■	—	GASKET.....	1	20	—	FLUID NIPPLE.....	1
6★■	—	PACKING.....	1	21	—	WASHER	1
7	—	PACKING GLAND NUT	1	22	—	NUT.....	1
8	—	GUN BODY	1	23	—	FLUID NIPPLE ASSEMBLY	1
9	—	SPRAY PATTERN VALVE	1	24	—	TRIGGER PIN ASSEMBLY	1
10■	—	U-CUP SEAL	2	25	—	TRIGGER	1
11■	—	AIR VALVE SEAT	1	26■	—	ASSEMBLY TOOL.....	1
12	—	AIR VALVE STEM	1				
13■	—	AIR VALVE SPRING	1				
14	—	AIR VALVE BUSHING.....	1				

★ K-5052 Pressure Gun Fluid Tip and Needle Replacement Kit (includes 1.1 and 1.4 mm tips & needles)

• K-5052-18 Pressure Gun Fluid Tip and Needle Replacement Kit (1.8 mm)

■ K-5057 Soft Parts Kit

NOTE: Use 1.1 mm fluid tip/needle with low viscosity materials.
Use 1.4 mm fluid tip/needle with high viscosity materials.

BINKS SV100 HVLP PRESSURE FEED SPRAY GUN

SPRAY TECHNIQUE

The first requirement for a good resultant finish is the proper handling of the gun. The gun should be held perpendicular to the surface being covered and moved parallel with it. The stroke should be started before the trigger is pulled and the trigger should be released before the stroke is ended. This gives accurate control of the gun and fluid.

The distance between gun and surface should be 6 to 8 inches depending on fluid and atomizing pressure. The fluid deposited should always be even and wet. Lap each stroke over the preceding stroke to obtain a uniform finish.

NOTE

To reduce overspray and obtain maximum efficiency always spray with the lowest possible atomizing air pressure.

GENERAL SPRAY INSTRUCTIONS

To reduce overspray and obtain maximum efficiency, always spray with the lowest possible fluid/air pressure that produces an acceptable spray pattern.

Excessive atomizing air pressures can increase overspray, reduce transfer efficiency, and with some materials, result in poor finish quality from dry spray. Atomizing air pressures should not exceed 10 psi. Compliance can be checked by having a pressure no greater than 26 psi at the gun inlet.

OPERATING THE SV100 HVLP SPRAY GUN

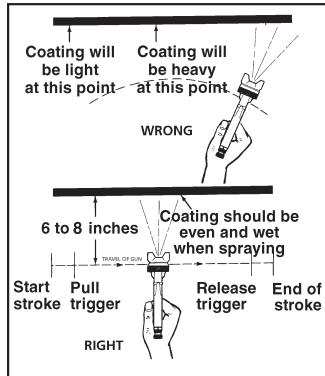

For best results, use 3 to 6 psi fluid pressure. Higher than 6 psi fluid pressure may be required for heavy-bodied materials. Low fluid pressures will produce a narrower than normal spray pattern. Generally use up to 20 psi air at **GUN INLET**. Unusually heavy, difficult to atomize fluids may require up to 26 psi air at gun inlet.

CONTROLLING THE FAN SPRAY

The fan spray is controlled by means of the side port control assembly. Turning this control clockwise until it is closed will give a round spray; turning it counterclockwise will widen the spray into a fan shape. The fan spray can be turned anywhere through 360° by positioning the air nozzle relative to the gun. To accomplish this, loosen retaining ring, position nozzle, then tighten retaining ring.

CONTROLLING THE FLUID FLOW

When used with a pressure assisted cup, an increase in air pressure will increase the rate of flow. When fed from a pressure supply, an increase in the fluid pressure will increase the rate of flow. Correct fluid nozzle size should be selected for correct fluid flow rate. The fluid control knob may be used for minor adjustment of fluid flow.

AIR NOZZLE, FLUID NOZZLE, FLUID NEEDLE

1. All nozzles and needles are precision made. They should be handled with care.
2. Do not make any alterations in the gun. To do so could cause finishing difficulties.
3. To clean nozzles, soak them in solvent to dissolve any dried material, then blow them clean with air.
4. Do not probe any of the holes in the nozzles with metal instruments. If probing is necessary, use only a tool that is softer than brass.

TROUBLESHOOTING

Faulty Spray

A faulty spray pattern is often caused by improper cleaning resulting in dried materials around the fluid nozzle tip or in the air nozzle. Soak these parts in thinners to soften the dried material and remove with a brush or cloth.

CAUTION

Never use metal instruments to clean the air or fluid nozzles. These parts are carefully machined and any damage to them will cause faulty spray.

If either the air nozzle or fluid nozzle are damaged, these parts must be replaced before perfect spray can be obtained.

Intermittent Spray

If the spray flutters, it is caused by one of the following faults:

1. Insufficient fluids available. Check supply and replenish if necessary.
2. Pressure vent tube from gun body to pressure pot is loose or leaking.
3. Check valve in pressure relief valve is stuck or blocked.
4. Pressure pot cover not sufficiently tight or cover gasket defective.
5. Insufficient fluid pressure from standard pressure pots.
6. Pickup tube in pressure pot bottoming out if 1-gallon pot is used.

NOTES

WARRANTY

This product is covered by Binks' 1 Year Limited Warranty.

Binks Worldwide Sales and Service Listing: www.binks.com

ITW Industrial Finishing

Binks has authorized distributors throughout the world. For technical assistance or the distributor nearest you, see listing below.

U.S./Canada Technical Service Office:

195 Internationale Blvd., Glendale Heights, IL 60139
Toll-Free Telephone: 1-888-992-4657 (U.S.A. and Canada only)
Toll-Free Fax: 1-888-246-5732

77-2874R-1 Revisions: (P5) Updated Parts List.



An Illinois Tool Works Company