

# INDUSTRIAL

*Blast Facilities*

by **CLEMCO**<sup>®</sup>

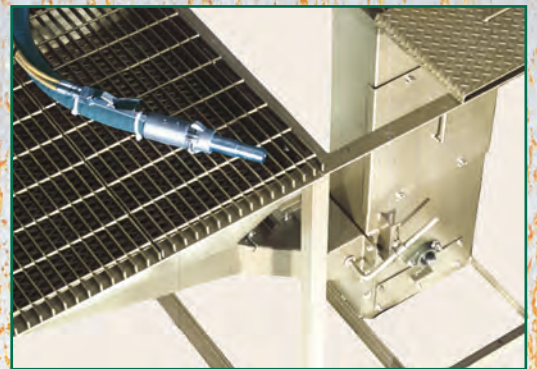
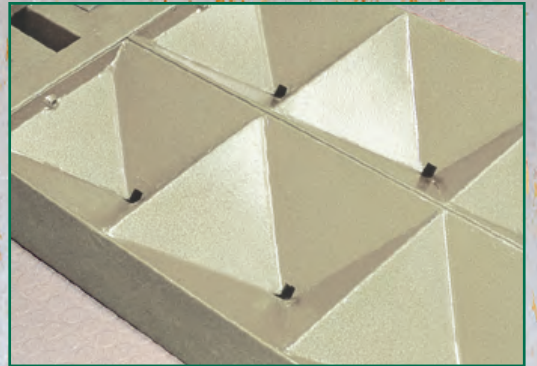

# *Sweep-in*

*Abrasive Recovery Systems*



# Sweep-in

## Abrasive Recovery Systems by Clemco®

**Save Time and Labor**  
**Reduce Abrasive Costs**  
**Reduce Disposal Costs**

*with economical,  
low-maintenance sweep-in  
recovery systems*

### Cost Saving & Productivity Gains

Installing a Clemco sweep-in recovery system allows you to select from a wide range of recyclable blast media — glass bead, aluminum oxide, plastic, steel shot and grit, cut wire, and more.

Expendable abrasives are inexpensive and widely available, but they break down rapidly often after just one use. The used abrasive dust must be packed for disposal, possibly as hazardous waste if it contains paint dust.

Recyclable abrasives cost more to buy, but can cut your annual media costs. For example, steel grit costs about ten times more per ton than mineral abrasives, but can be recycled hundreds of times. Depending on the application, steel grit cleans at rates comparable to mineral abrasives. And when the steel grit does break down, the dust and fine particles are carried automatically to the dust collector and are deposited in the dust drum for disposal.

Stop blasting outdoors, where weather dictates your schedule. Blast all day, even 'round the clock when production needs demand it — without stirring discontent among your neighbors or the EPA.

A sweep-in recovery system, with a high-efficiency dust collector, is an economical alternative to a full-floor recovery system. It can be installed in an existing blast room or ordered with a new enclosure.

A sweep-in recovery system automatically cleans recyclable abrasives and transports the good media to the blast machine. Your operators blast until media builds up on the enclosure floor; then they use brooms, shovels, compressed air, even small tractors to push the abrasive into the recovery system.

By cleaning and recycling the abrasive, a sweep-in recovery system saves material costs, compared to using expendable abrasives. And, with an in-floor recovery system, you spend more time blasting, less time handling abrasives.

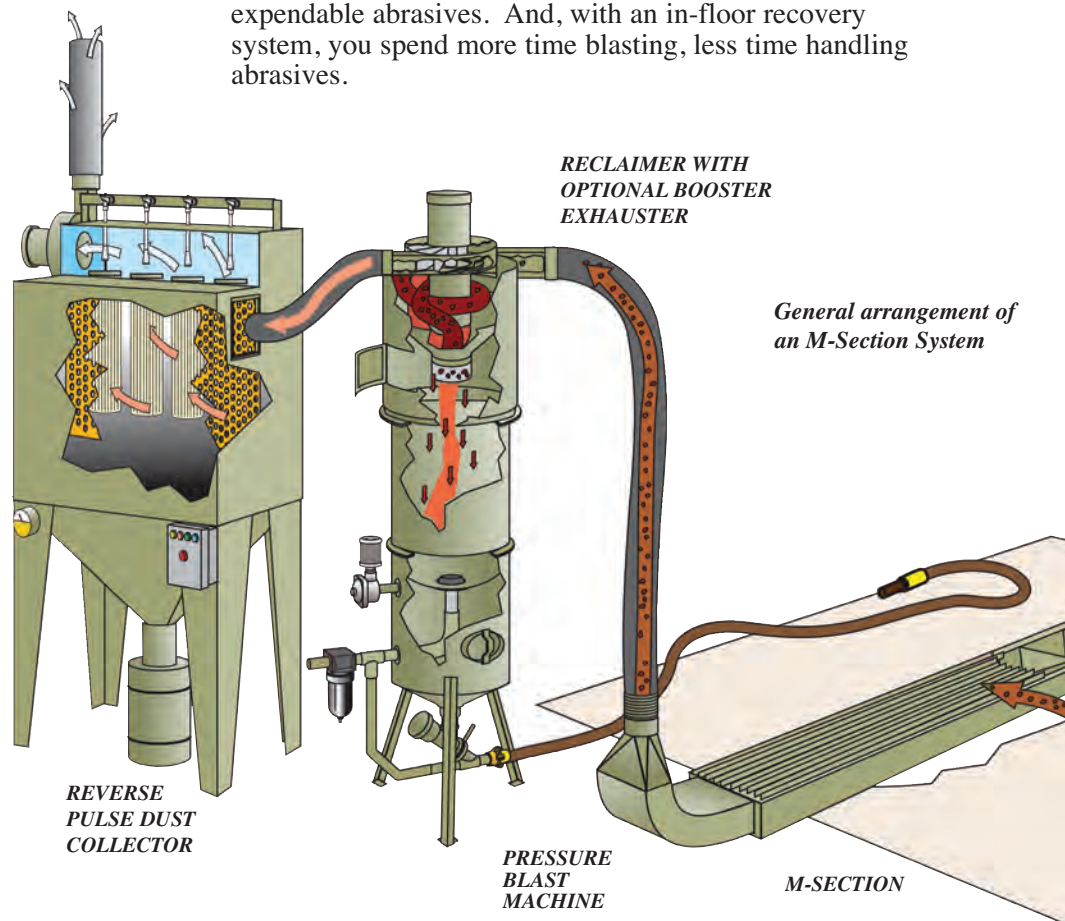

# Standard and Custom Sweep-In Systems

## M-SECTION® Systems for glass bead, plastic media and aluminum oxide

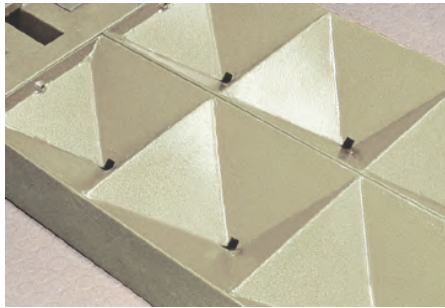

**O**ur standard sweep-in M-Section® pneumatic recovery systems efficiently recover and recycle most medium and low-density blast media, such as glass bead, plastic, and aluminum oxide up to 36 grit and others less than 100 lbs per cubic foot. The recovery section unit recesses in a shallow channel, just 8 inches deep, for a true sweep-in operation, or can be surface-mounted where conditions will not allow excavation.

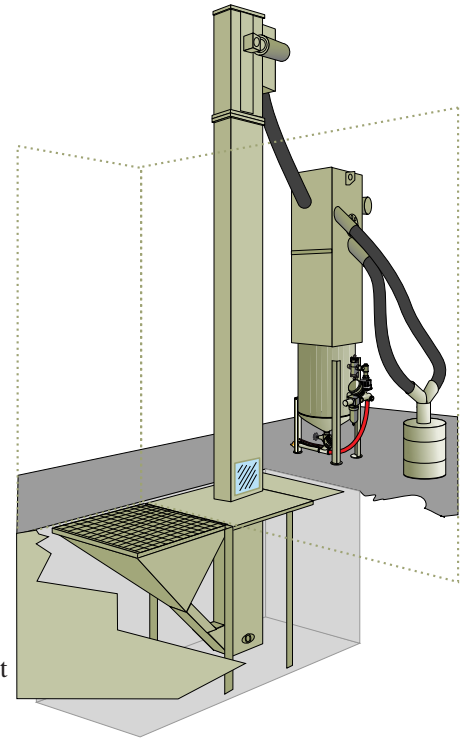

**3 X 3 HOPPER SYSTEM**

## HOPPER Systems for steel grit and shot

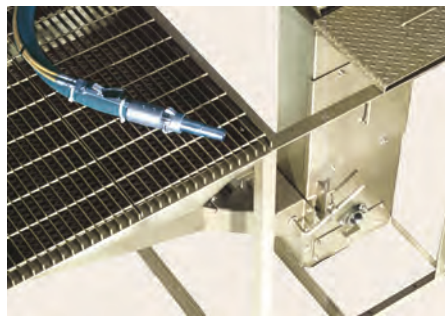

**O**ur hopper recovery systems, with bucket elevator, process up to 180 cubic feet per hour of dense and coarse media, such as steel grit and shot. With the 3 ft. x 3 ft. hopper system, flush mounting requires a pit just 4 1/2 feet deep. Where a high water table prevents excavation, the smaller 2 ft. x 2 ft. system can be wall-mounted and shovel-fed.

## BELT CONVEYOR Systems for steel grit and shot

**D**esigned primarily for heavy abrasives, such as steel and other heavy coarse-mesh media, our two standard belt conveyor sweep-in systems can continuously reclaim up to 180 cuft of abrasive per hour and are available in standard lengths of 10 feet and 20 feet, and up to 100 feet long by special order. Belt systems feature a durable 12-inch wide belt, 2 HP drum motor, air-wash abrasive cleaner, bucket elevator and floor grating to cover the in-floor belt and recovery hoppers.

These systems offer low-cost operation, consuming only a fraction of the power needed to run a screw recovery system, and require little maintenance. The hopper feeds material to the belt through a tube in a controlled manner preventing belt overload and media overflow.

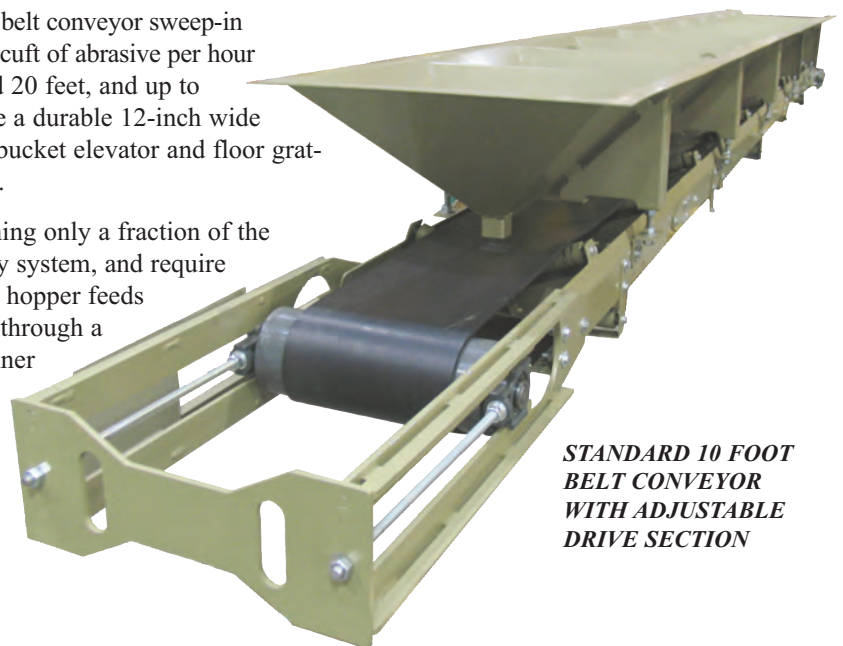
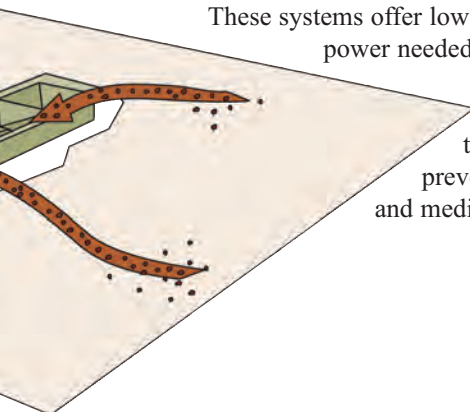

**STANDARD 10 FOOT BELT CONVEYOR WITH ADJUSTABLE DRIVE SECTION**

# Specifications and Options

	BELT CONVEYOR	HOPPER	M-SECTION®
<b>Floor Recovery Components</b>	1 ft. wide continuous belt, 2 HP drum motor, 10-gauge steel construction	2 ft. x 2 ft. surface-mount hopper, or 3 ft. x 3 ft. recessed hopper	1 ft. wide “M” shaped recovery channel
<b>Floor Recovery Area</b>	3 ft. wide x 10 ft. or 20 ft. long; longer sections up to 100 ft. by special order	N/A	1 ft. wide by 8 ft., 10 ft., or 12 ft. long
<b>Grating</b>	250 lbs/ sq.ft. uniform load	250 lbs/ sq.ft. uniform load	2000 lbs/ sq.ft. uniform load
<b>Media Transfer</b>	Bucket elevator with poly buckets on 4-inch wide belt; 1 hp motor	Bucket elevator with poly buckets on 4-inch wide belt; 1 hp motor	Vacuum duct to media reclaimer (2 hp motor mounted on reclaimer with optional dry filter)
<b>Media Cleaning</b>	Air-wash abrasive cleaner; 1/4 hp motor	Not included but needed: Air-wash abrasive cleaner; 1/4 hp motor. Order separately.	Adjustable cyclonic separator with wear plate
<b>Media Storage</b>	56 cu.ft. total (50 cu.ft. storage hopper, atop 6 cu.ft. blast machine)	16 cu.ft. total (10 cu.ft. abrasive cleaner atop 6 cu.ft. blast machine)	12 cu.ft. total (6 cu.ft. hopper atop 6 cu.ft. blast machine)
<b>Dust Collection</b>	Ventilates abrasive cleaner. Blast room dust collector must be ordered separately	Not included; order separately, one for ventilating the abrasive cleaner, another for ventilating the blast room	900 cfm dry filter or self-cleaning RP-cartridge collector (2hp motor mounted on RP collector).Ventilates media reclaimer only. Blast room dust collector must be ordered separately
<b>Blast Machine</b>	ASME-code 6 cu.ft. capacity stationary blast machine with Sentinel metering valve, TLR-300 pneumatic remote controls with ACS, 1-1/4” ID coupled blast hose and TXP-6 nozzle	Order Separately	ASME-code 6 cu.ft. capacity stationary blast machine with fine mesh Sentinel metering valve, TLR-300 pneumatic remote controls with ACS, 1-1/4” ID coupled blast hose and TXP-6 nozzle
<b>Electrical Specifications</b>	230/460 volt, 3 phase, 60 hz. Please specify	230/460 volt, 3 phase, 60 hz. Please specify	230/460 volt, 3 phase, 60 hz. Please specify
<b>Operator Safety Equipment</b>	Apollo 600 HP DLX supplied-air respirator, Clem-Cool air conditioner, respirator hose, CPF- breathing-air filter, heavy-duty blast suit, gloves, and replacement lenses	Order Separately	Order Separately
<b>Start-Up Supervision</b>	One technician for one day	Order Separately	Order Separately
<b>Other Options</b>	<ul style="list-style-type: none"> <li>• 600 cfm abrasive-cleaner dust collector with 1 hp motor or RP-cartridge collector with 1 hp motor (required if room ventilation system cannot accommodate abrasive cleaner ventilation)</li> <li>• 100 or 200 cu. ft. storage hopper</li> </ul>	<ul style="list-style-type: none"> <li>• 600 cfm abrasive-cleaner dust collector with 1 hp motor or RP-cartridge collector with 1 hp motor (required if room ventilation system cannot accommodate abrasive cleaner ventilation)</li> </ul>	<ul style="list-style-type: none"> <li>• Rubber-lined reclaimer for aggressive media</li> <li>• 12 or 18 cu.ft. storage hopper to extend blasting time between recovery cycles</li> <li>• Ramp plates to enhance access to surface-mounted recovery channel</li> </ul>

## Outstanding Distributor Support

Our Authorized Distributors can help you plan the blast facility that works best for your application and budget.

For the name of your local Distributor and a free Industrial Planning Guide, visit us online at [www.clemcoindustries.com](http://www.clemcoindustries.com).

Distributed by:

*ISO 9001:2008 certified. Clemco is committed to continuous product improvement. Specifications are subject to change without notice.*