



rpb® T150 FACE MASK™

CONTENTS

Read all instructions and warnings before using this product.
Keep this manual for future reference.

NIOSH - CAUTIONS AND LIMITATIONS	3
INTRODUCTION	4
RESPIRATORY COMPONENT CONCEPT	5
!WARNINGS!	6
RESPIRATOR OPERATION	8
SPECIAL OR CRITICAL USER INSTRUCTIONS - BREATHING AIR PRESSURE TABLE	9
RESPIRATOR SETUP AND USE	10
INSPECTION, MAINTENANCE, CLEANING & STORAGE	12
PARTS AND ACCESSORIES	14

RPB Safety Global Headquarters 2807 Samoset Rd, Royal Oak, MI 48073, USA.
T: 1-866-494-4599 F: 1-866-494-4509 E: sales.us@rpbsafety.com www.rpbsafety.com

RPB Safety Asia Pacific Headquarters 652 Halswell Junction Road, Hornby South 8042
New Zealand. T: +64-3-357-1761 F: +64-3-357-1763 E: sales.nz@rpbsafety.com
www.rpbsafety.com

RPB® and advancing your safety are registered trademarks of RPB® Safety

For technical assistance contact our Customer Service Department on
1-866-494-4599 or email: customerservice@rpbsafety.com

Form #: 7.20.521
Rev: 0



RPB Safety
T. 1 866 494 4599 F. 1 866 494 4509 E. info@rpbsafety.com

TYPE C, CONTINUOUS FLOW, SUPPLIED-AIR RESPIRATOR
 THESE RESPIRATORS ARE APPROVED ONLY IN THE FOLLOWING CONFIGURATIONS

RESPIRATORY COMPONENTS																
TC No.	Protection ¹	Model	Visor & Face Seal		Alternate Lenses		Head Gear		Breathing Tube	Alternate Flow Control Devices			Alternate Hoses			Cautions and Limitations ²
			11-910	11-924	11-933	11-934	030-031	03-101	NV2016	03-106	NV2028	NV2029	NV2027	NV2035	NV2036	
19C-0502	SA/CF	T150	X	X	X	X	X	X	X	X	X	X	X	X	X	ABCDEJMNS

1. PROTECTION

CF – Continuous Flow SA – Supplied Air

2. CAUTIONS AND LIMITATIONS

- A - Not for use in atmospheres containing less than 19.5% oxygen.
- B - Not for use in atmospheres immediately dangerous to life or health.
- C - Do not exceed maximum use concentrations established by regulatory standards.
- D - Air-line respirators can be used only when the respirators are supplied with respirable air meeting the requirements of CGA G-7.1 Grade D or higher quality.
- E - Use only the pressure ranges and hose lengths specified in the User’s Instructions.
- J - Failure to use and maintain this product properly could result in injury or death.
- M - All approved respirators shall be selected, fitted, used and maintained in accordance with MSHA, OSHA, and other applicable regulations.
- N - Never substitute, modify, and, or omit parts. Use only exact replacement parts in the configuration specified by the manufacturer.
- O - Refer to user instruction and/or maintenance manuals for information about use and maintenance of these respirators.
- S - Special or critical User’s Instructions and/or specific use limitations apply. Refer to User’s Instructions before donning.

rpb[®] T150 FACE MASK[™]

INTRODUCTION

The T150 Supplied Air Respirators are designed to provide protection from airborne contaminants in atmospheres NOT IMMEDIATELY DANGEROUS TO LIFE OR HEALTH, and from which a user can escape without the aid of the respirator, or that do not exceed concentrations allowed by OSHA, EPA or NIOSH regulations and recommendations.

The T150 is NIOSH approved (Type C Supplied Air Respirator) to provide respiratory protection in general applications. The helmet meets ANSI Z87.1 for Eye and Face Protection.

T150 Respirators are NIOSH Approved for use with the NV2016 Flow Control Valve, 03-101 Constant Flow Valve and 03-106 Low Pressure Valve.

All RPB[®] products are covered by a manufactures warranty of 3 months. The manufacturer warranty covers defects in material, workmanship and does not cover damage caused by misuse or abuse. RPB[®] Safety's only obligation and your exclusive remedy shall be to repair, replace or refund the purchase price of such parts or products upon the presentation of proof of purchase. Maximum liability is in no case to exceed the value of the RPB[®] Safety Product involved.

RESPIRATOR COMPONENT CONCEPT

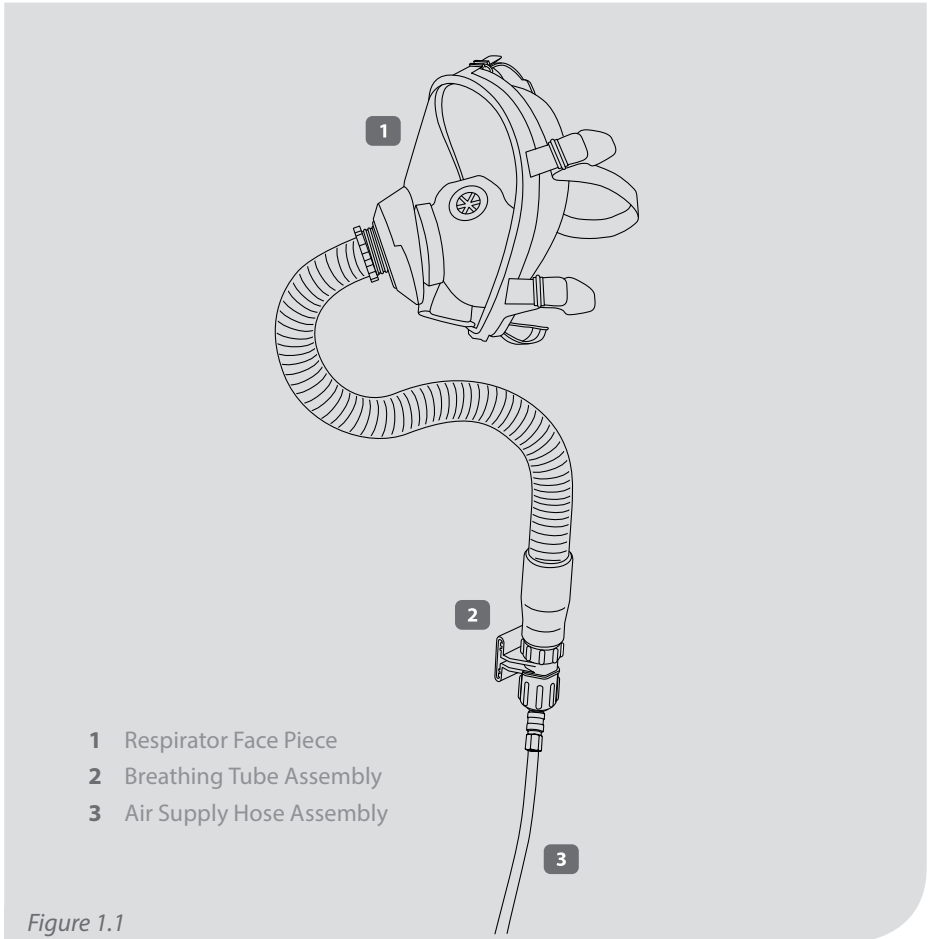

!WARNING! Failure to use genuine parts and components that are part of the NIOSH approved respirator assembly will void the approval of the entire respirator assembly.

RPB™ T150 FACE MASK™

!WARNINGS!

- 1** Do not use this respirator until you have been trained in the respirators use, maintenance and limitations by a qualified individual (appointed by your employer) who has extensive knowledge on the T150 Full Face Respirator. All training must be in accordance with this Users Instruction Manual.
- 2** Before using this respirator ensure your employer has determined that airborne contaminant concentrations do not exceed those allowed by applicable OSHA, EPA or NIOSH regulations and recommendations for continuous flow supplied air respirators. Federal law requires that the employer measures and monitors airborne contaminant levels in the work area.
- 3** Do not wear this respirator if any of the following conditions exist
 - Atmosphere is immediately dangerous to your life or health
 - You CAN NOT escape without the aid of the respirator
 - Atmosphere contains less than 19.5% oxygen
 - Work area is poorly ventilated
 - Contaminants are in excess of regulations or recommendations
- 4** Do not modify or alter this respirator. Use only parts and components that are part of the NIOSH approved respirator assembly. The use of non RPB® parts voids the NIOSH approval of the entire respirator assembly.
- 5** Inspect all components of the respirator daily for signs of damage or wear and tear that may reduce the level of protection originally provided.
- 6** Do not use silica sand or abrasives containing silica, lead, arsenic or sharp glass particles - use of abrasive containing these elements could result in serious injury or death.
- 7** Do not wear this respirator until you have passed a complete physical exam including a lung X-ray conducted by qualified medical personnel.
- 8** Improper use of this respirator or use not in accordance with this User Instruction Manual may cause injury or death. Improper use may also cause life threatening delayed lung diseases such as silicosis, pneumoconiosis or asbestosis.
- 9** This respirator, when properly fitted and used, significantly reduces but does not completely eliminate the breathing of contaminates by the respirator wearer.
- 10** Be certain your employer has determined that the breathing air source provides at least a Grade D breathable air as specified in the compressed gas association commodity specification G-7.1. The respirator must be supplied with clean breathable air at all times. A carbon monoxide monitor must be used at all times. Contact your RPB® distributor for a Radex 08-200 CO Monitor.
- 11** RPB® cannot accept any liability of whatsoever nature arising directly or indirectly from the use or misuse of RPB®

products, including purposes that the products are not designed for. RPB® is not liable for damage, loss or expense resulting from the failure to give advice or information or the giving of incorrect advice or information, whether or not due to RPB's® negligence or that of its employees, agents or sub-contractors.

- 12** Do not connect the respirator's air supply hose to nitrogen, toxic gases, inert gases or other unbreathable non Grade D air sources. Check the air source before using the respirator. This apparatus is not designed for use with mobile air supply systems i.e. cylinders. Failure to connect the supply hose to the proper air source could result in serious injury or death.
- 13** If this respirator is used in confined spaces ensure the area is well ventilated and that all contaminate concentrations are below those recommended for this respirator. Follow all procedures for confined space entry, operation and exit as defined in applicable regulations and standards.
- 14** Leave work immediately if:
 - Any respirator component becomes damaged.
 - Airflow stops or slows down
 - Breathing becomes difficult
 - You become dizzy, nauseous, too hot, too cold or ill.
 - Vision is impaired.
- 15** T150 Full Face Respirators do not provide hearing protection. Earplugs or earmuffs must be properly fitted when exposed to noise levels that exceed the OSHA permissible exposure levels.

NIOSH - CAUTIONS AND LIMITATIONS

- A** Not for use in atmospheres containing less than 19.5 percent oxygen.
- B** Not for use in atmospheres immediately dangerous to life or health.
- C** Do not exceed maximum use concentrations established by regulatory standards
- D** Air-line respirators can be used only when the respirators are supplied with respirable air meeting the requirements of CGA G-7.1 Grade D or higher quality.
- E** Use only the pressure ranges and hose lengths specified in the user's instructions
- J** Failure to properly use and maintain this product could result in injury or death.
- M** All approved respirators shall be selected, fitted, used and maintained in accordance with MSHA, OSHA, and other applicable regulations.
- N** Never substitute, modify, add or omit parts. use only exact replacement parts in the configuration as specified by the manufacturer.
- O** Refer to user's instructions, and/or maintenance manuals for information on use and maintenance of these respirators.
- S** Special or critical user's instructions and/or specific limitations apply. Refer to user's instruction page 11 (breathing air pressure table) before donning.

RESPIRATOR OPERATION

AIR QUALITY

This respirator must be supplied with clean breathable air at all times. Breathable air must at least meet the requirements for Type 1 gaseous air described in the Compressed Gas Association Commodity Specifications G.7.1 (Grade D or higher) and as specified by Federal Law 42 CFR 84, subpart J.84.141(b) and 29 CFR 1910.134 (i) the T150 does not purify air or filter contaminants.

AIR SOURCE

Locate the air source in a clean air environment; always use a filter on the inlet of your air source. Do not park vehicles beside your air inlet as this will cause carbon monoxide to be drawn into your air supply. Always use suitable after coolers / dryers with filters and carbon monoxide alarms to ensure clean breathable air is supplied at all times. The air should be regularly sampled to ensure that it meets Grade D requirements.

BREATHING AIR SUPPLY HOSES AND FITTINGS

RPB[®] air supply hoses and fittings must be used between the point of attachment and the respirator breathing air connection at the wearer's belt. The hose sections must be within the correct length and the amount of sections must be within the number specified in the breathing air pressure table on page 9.

BREATHING AIR PRESSURE

The air pressure must be continually monitored at the point of attachment. Air pressure must be read from a reliable pressure gauge whilst the respirator has air flowing through it.

NEGATIVE PRESSURE FIT CHECK

Test the respirator facepiece for tightness by placing the palm of your hand over the threaded hole for the breathing tube in the front of the facepiece. Inhale gently so that the facepiece collapses slightly and hold your breath for ten seconds. The facepiece will remain collapsed if the assembly is gas tight. If the facepiece does not remain collapsed, readjust the head harness straps and re-test. If any leakage is

detected, investigate the condition and correct. The facepiece must be subjected to a tightness test without detection of leakage before each use.

RESPIRATORY FIT TEST

It is an OSHA requirement that a qualitative or quantitative respirator fit test is carried out for each wearer before use as per the Respiratory Standard, 29 CFR 1910.134. The fit test is required to determine the amount of protection the respirator will provide, this test should be performed prior to initial use, whenever a different respirator is used, and at least annually thereafter. An additional fit test must also be performed whenever there are changes in the employee's physical condition that could affect the respirator fit, such as dental changes or an obvious change in body weight. RPB recommends that a Quantifit Tester is used for this testing operation. The minimum fit factor of a full face respirator is 500.

!WARNING! Failure to supply the minimum required air pressure at the point of attachment for the length of air supply hose could result in contaminants being inhaled as the pressure in the helmet may become negative due to peak inhalation flow when working at very high work rates. The T150 Breathing Air Pressure table on page 11 defines the air pressure ranges needed to provide the respirator with a volume of air which falls in the required range of 6-15cfm or 170-425 lts/min.

!WARNING! Make sure you understand the Breathing Air Pressure table before using this respirator.

- 1 Determine your air source (column 1)
- 2 Identify your breathing tube assembly (column 2)
- 3 Confirm the part number of the air supply hose you are using (column 3)
- 4 Check your RPB[®] Air Supply Hose is within the correct length (column 4)
- 5 Set the air pressure at the point of attachment within the range specified (column 6) for your breathing tube assembly, hose length and number of hose sections. (column 5)

Make sure air is flowing through your respirator when setting the air pressure.

SPECIAL OR CRITICAL USERS INSTRUCTIONS

BREATHING AIR PRESSURE TABLE

This table lists air pressure ranges needed to provide the T150 with the volume of air that falls within the required range of 6-15cfm or 170-425 lts/min according to U.S government regulations.

1. AIR SOURCE	2. BREATHING TUBE AND FLOW CONTROL DEVICES	3. AIR SUPPLY HOSE	4. SUPPLY HOSE LENGTH (FT)	5. MAX NUMBER OF SECTIONS	6. PRESSURE RANGE (PSIG)
Portable or Stationary Compressor	03-031 03-101	NV2027 (100ft) NV2028 (25ft) NV2029 (50ft)	25	1	5 - 6
			50	1	6 - 8
			100	2	9 - 10
			150	3	11 - 12
			200	4	13 - 14
			250	5	15 - 16
300	6	17 - 18			
Portable or Stationary Compressor	03-031 NV2016	NV2027 (100ft) NV2028 (25ft) NV2029 (50ft)	25	1	12 - 13
			50	1	14 - 15
			100	2	16 - 17
			150	3	17 - 18
			200	4	19 - 20
			250	5	20 - 21
300	6	22 - 24			
Portable or Stationary Compressor	03-031 03-106	NV2036 (100ft) NV2035 (50ft)	50	1	2.0 - 2.5
			100	1	2.5 - 3.0
			150	2	3.5 - 4.0
			200	2	4.2 - 4.7
			250	3	5.0 - 5.5
			300	3	5.2 - 5.7

!WARNING! The T150 Supplied Air Respirator must be supplied with respirable air meeting the requirements of CGA G-7.1 Grade D or higher quality.

RESPIRATOR SETUP AND USE

CONNECTING THE AIR SUPPLY

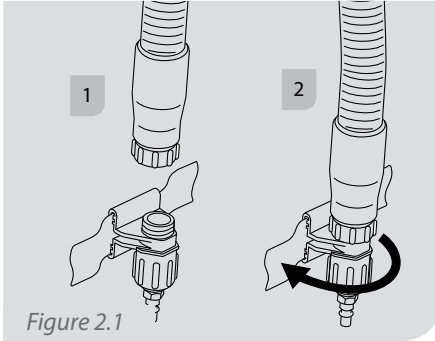

Thread on the loose running nut of the 03-031 Breathing Tube on to the Flow Control Device. Screw the running nut in a clockwise direction until tight.

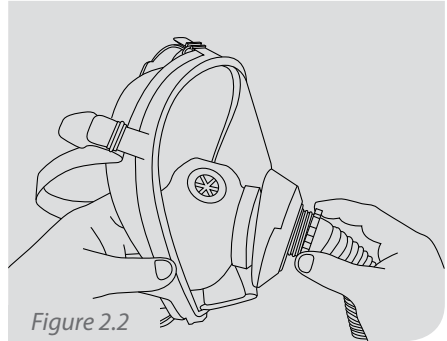

Connect the 03-031 Breathing Tube to the Face Piece. Turn anti clockwise until tight. Clip the hose into the support clip at the side of the visor.

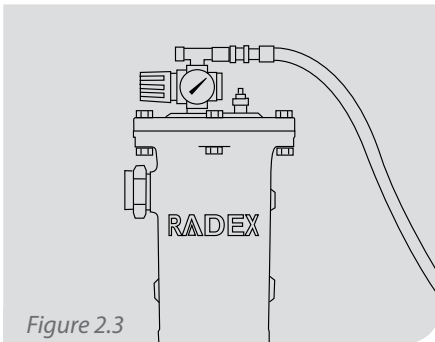

Connect the Breathing Air Supply Hose to the point of attachment and adjust the pressure to suit the Breathing Air Pressure Table.

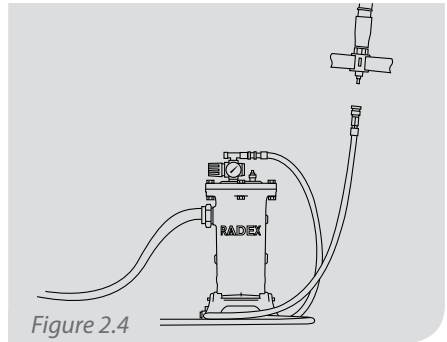

Connect the Air Supply Hose to the Flow Control Device. Air should be now flowing through the Respirator. Confirm the pressure is still in accordance with the Breathing Air Pressure Table.

DONNING YOUR RESPIRATOR MASK

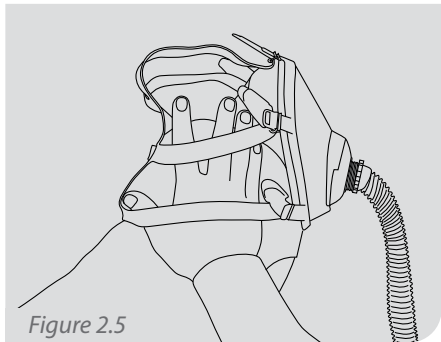

Figure 2.5

Put head harness behind your neck and keep the two lower straps of the harness open with your hands.

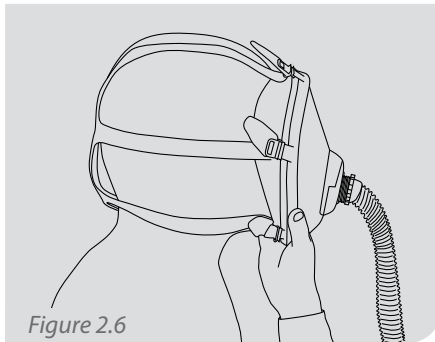

Figure 2.6

Pull the mask down putting your chin in first while making sure it fits snugly over your face.

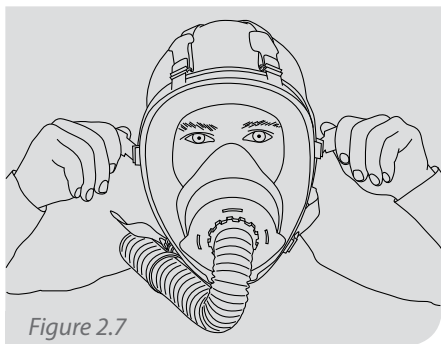

Figure 2.7

Adjust the mask on your face, by firstly adjusting the side straps, then the upper and finally the lower ones. Perform a FIT Check (See page 8 for instructions).

DOFFING YOUR RESPIRATOR MASK

When you have finished working, leave the work area wearing the respirator with air flowing into the helmet. Once outside the contaminated area remove the respirator and disconnect the air supply hose.

!WARNING! NEVER remove your Respirator while you are in the work areas as this may result in serious injury or death.

INSPECTION, MAINTENANCE, CLEANING AND STORAGE

As the T150 Supplied Air Respirator has a limited service life, a regular inspection and replacement programme must be conducted. Before using the Respirator all parts should be inspected for damage or wear and tear. Replace all worn or damaged

parts immediately. Use only parts and components that are part of the NIOSH approved respirator assembly. Refer to Parts and Accessories section on pages 22-25 part numbers.

HOW TO CLEAN AND INSPECT THE C150

TYPE OF ACTION	BEFORE USE (NEW MASK)	BEFORE EVERY USE	AFTER EVERY USE	MONTHLY	EVERY FIVE YEARS
CLEANING			X		
DISINFECTING			X*	X	
GENERAL VISUAL CHECK	X	X		X	
INHALATION VALVE REPLACEMENT					X
INNER MASK VALVES REPLACEMENT					X
TIGHTNESS CHECK		X			

* Not in case of individual user

MAINTENANCE

Monthly and before use check (general visual check)

Examine the mask and check it according to point 4.1. Use the same procedure for monthly check. If the mask has any defects it must not be used before the faulty parts are replaced.

BREATHING TUBE ASSEMBLY

Inspect the Breathing Tube 03-031 for splits or excessive wear. Check that the fittings are secured into the tube and are not allowing any air to escape. Replace the tube as soon as signs of damage or excessive wear become evident. Do not remove the foam that is inside the Breathing Tube as it reduces the noise level of the incoming air.

!WARNING! Do not clean this respirator with volatile chemicals.

CLEANING AND DISINFECTING

Take particular care of any contaminants deposited on the mask. All cleaning should take place in safe areas. Do not use abrasive substances or solvents to clean the visor. Use exclusively this procedure to clean and disinfect the mask:

- 1 After removing mask and contaminated filter, clean under running water to remove most of the contaminants; then clean more fully by placing in hot water (temperature not upper to 40°C) with a neutral soap. If disinfection is required, use a solution of common disinfectant based on quaternary ammonium compounds.
- 2 Dry the mask with a soft, clean cloth or let it dry naturally.
- 3 Clean the dry visor with clean cotton wool.

AIR SUPPLY HOSE

The air supply hose should be inspected for cuts, cracks, blisters and signs of abrasion. Make sure the fittings are firmly crimped to the hose and air cannot escape. Make sure the hose has not been crushed or kinked. Replace the hose immediately if there are any signs of damage. Do not run water through the inside of the hose. Clean the Quick Disconnect Couplings with an air blow down gun to remove any sand or dirt that may jam the coupler.

!WARNING! USE ONLY RPB® AIR SUPPLY HOSES.

rpb[®] T150 FACE MASK™

PARTS AND ACCESSORIES

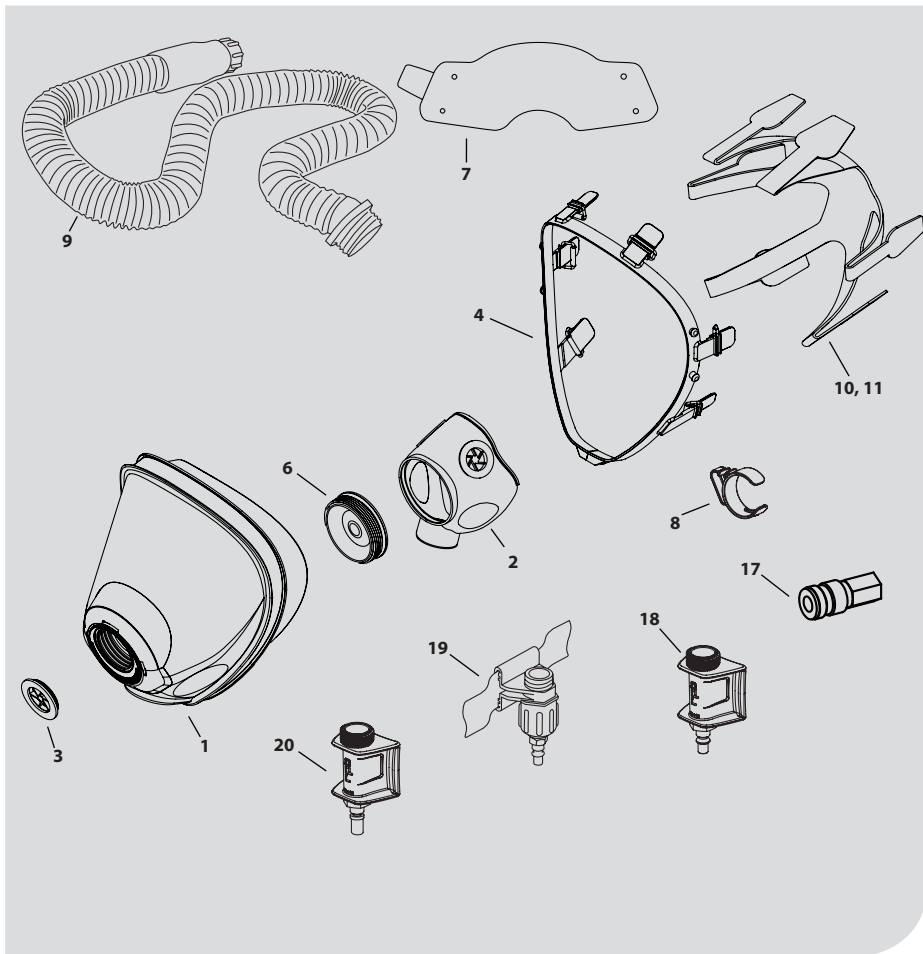

!WARNING! Use only parts and components that are part of the NIOSH approved respirator assembly. The use of non RPB[®] parts voids the NIOSH approval of the entire respirator assembly.

Item No.	Description	Part Number
1	Main Visor	11-910
2	Inner Face Seal	11-911
3	Inhalation Valve	11-912
4	Clamping Band	11-913
5	Non-return valve	11-914
6	Exhalation Valve	11-915
7	Tear off Lens	11-924
8	Breathing Tube Bracket	11-948
9	Breathing Tube	03-031
10	Rubber Head Suspension	11-933
11	Nylon Head Suspension Net (Comfort)	11-934
12	25ft Air Supply Hose $\frac{3}{8}$ " ID	NV2028
13	50ft Air Supply Hose $\frac{3}{8}$ " ID	NV2029
14	100ft Air Supply Hose $\frac{3}{8}$ " ID	NV2027
15	50ft Air Supply Hose $\frac{1}{2}$ " ID	NV2035
16	100ft Air Supply Hose $\frac{1}{2}$ " ID	NV2036
17	Quick Disconnect Coupler $\frac{1}{4}$ " BJP	NV2025
18	Constant Flow Valve	03-101
19	Flow Control Valve	NV2016
20	Constant Flow Valve (Low Pressure)	03-106

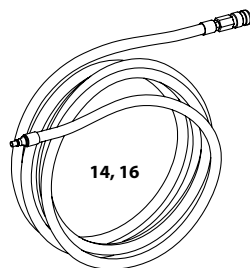
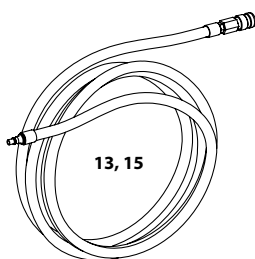
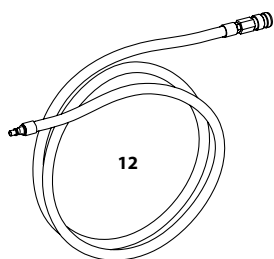

OTHER PRODUCTS

ISO9001
CERTIFIED COMPANY

RPB® NOVA 3® RESPIRATOR

The RPB® NOVA 3® combines breakthrough protection technology with advanced comfort and functionality, surpassing even the most rigorous industry standards and the demands of the most quality-conscious companies. Designed to optimize safety and productivity, and to minimize worker downtime, the helmet has a host of features that maximize its lifetime value.



AIRLINE FILTRATION

The RPB® RADEX AIRLINE FILTER™ offers increased capacity, versatility and filtration. This optional equipment combines the versatility of either floor or wall mounting with increased filtration capacity, enabling customization to meet worker's needs and working environments.



AIR QUALITY MONITORING

The RPB® RADEX CO MONITOR™ helps ensure worker safety with a unique traceability feature that monitors and records carbon monoxide levels, and temperature. This data that provides certainty of monitor functioning and can be stored for up to two years allowing analysis of plant and field air quality.



1 866 494 4599
www.rpbsafety.com

rpb®
ADVANCING
YOUR SAFETY